

TECHNICAL DATASHEET

ADRCV2460TD
60W 24V DC CONSTANT VOLTAGE TRIAC DIMMABLE



PRODUCT FEATURES

- Constant Voltage LED Power Supply
- Moulded Polycarbonate Body
- Overload Protection
- Regulated Output
- Thermal Cutout
- SELV Rated
- Triac Dimmable

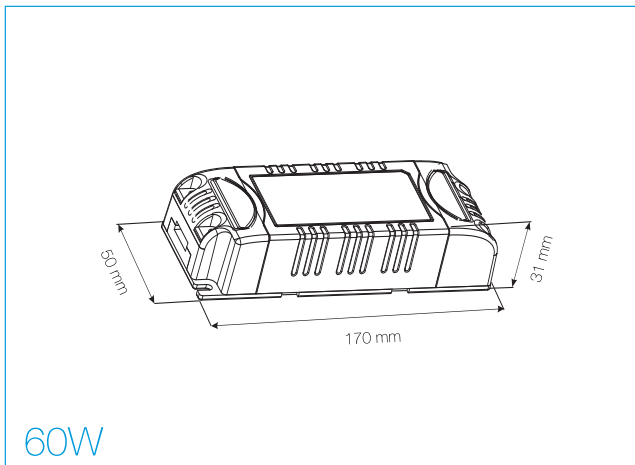

MAINS
DIMMABLE

PRODUCT CODE	ADRCV2460TD
Operating Voltage	180-240 V AC
Output Voltage	24V DC
Operating Load	45-60W
Output Current (Max.)	2.5A
Temperature	-30~+45°C