

TECHNICAL DATASHEET

AFPD006

6W LED Slimline Downlights



PRODUCT FEATURES

- White Finish
- Uniform Light Distribution
- Twist-Lock DC Connector Installed
- Pre-Flexed Driver Facilitating Quick Installation
- Slimline Design
- High Output LED Diodes

Options Available:

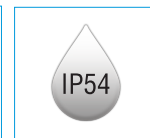
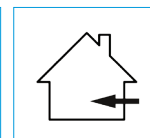
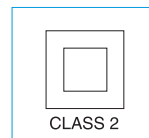
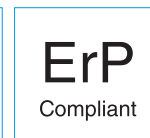
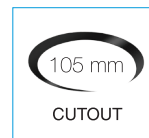
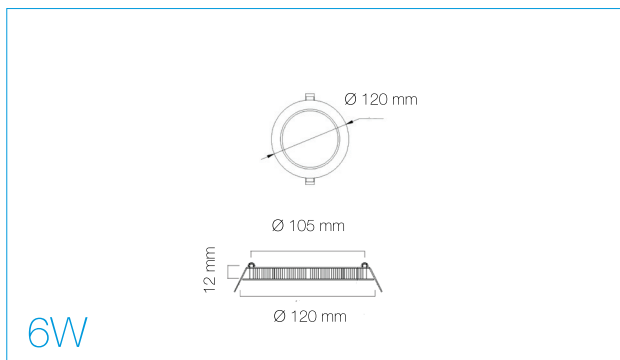
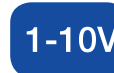

PRODUCT CODE	AFPD006/30	AFPD006/40
Power	6W	6W
Lumens	420 lm	450 lm
Colour Temperature	3000K	4000K
Beam Angle	120°	120°
CRI	>80	>80
IP	IP54	IP54
Lifetime (Hours to lm70)	25,000 h	25,000 h
Voltage	85-265V AC	85-265V AC
Temperature	-20°C ~ +60°C	-20°C ~ +60°C
Cutout Diameter	105 MM	105 MM